



Chemical Injection Technologies

Installation/Service Bulletin

SUPERIOR Gas Chlorinator/Sulfonator[‡]

Guide to Installation, Troubleshooting and Maintenance

IMPORTANT!! READ THESE PRECAUTIONS BEFORE PROCEEDING!!!

They are very important for your personal safety, and for proper chlorinator operation.

1. Read these precautions and all related instructions thoroughly and follow them carefully. If you do not understand any of the information, call your local SUPERIOR supplier or Chemical Injection Technologies, Inc. Do not attempt to install or operate any gas chlorination/sulfonation equipment unless you are properly trained.
2. Read the "CHLORINATOR CYLINDER CHANGING PROCEDURE" card supplied with your chlorinator, and be certain you fully understand the information presented on the card. If you do not have the card, contact your local SUPERIOR supplier or Chemical Injection Technologies, Inc. and we will supply one.
3. Make certain all required safety equipment is in place and operational.
4. When performing any maintenance or changing cylinders, Chemical Injection Technologies, Inc. strongly recommends that a gas mask (a pressure-demand type air pack is strongly recommended) should be available in the immediate area of the chlorination equipment and all operating personnel should be properly trained in its use.
5. Chlorine gas or the fumes from chlorine solutions can be lethal in large enough doses. Therefore, you should always have a co-worker observe from a safe location when you are working on any type of chlorination equipment.
6. Avoid breathing the gas or fumes of chlorine solutions and avoid contact with your skin. Work only in a well-ventilated area. Chlorine will bleach clothing.
7. Before working on the chlorination system, make certain that the cylinder valve is shut off. If it seems to be shut off already, open it one quarter turn and immediately close it to make certain that the valve is not frozen in the open position. If the valve stem does not turn easily, you may use the heel of your hand to tap the cylinder wrench. Never use a hammer or other tool to force the valve stem. If you cannot turn the cylinder valve in either direction, always assume it is open. **BE POSITIVE THIS VALVE IS CLOSED BEFORE LOOSENING THE CHLORINATOR MOUNTING YOKE OR VALVE CAP.** If you are not sure, call your chlorine supplier.
8. Do not use wrenches larger than the standard cylinder wrench and do not hit the wrench with a heavy object to open or close the valve.
9. Do not re-use lead gaskets. **THIS IS VERY IMPORTANT!** Do not re-use a lead gasket because used gaskets will not properly seal the chlorinator/cylinder connection and will cause leaks.
10. Use only lead gaskets. Other types may contract with temperature variations resulting in the escape of gas.
11. Check for chlorine gas leaks every time the chlorinator is connected or remounted onto the cylinder. Using a plastic squeeze bottle of strong ammonia, approximately 1/3 full, squeeze fumes under the lead gasket connection and around the cylinder valve bonnet and valve stem. A piece of rag or paper towel wetted with ammonia may also be held under the connection. *Do not pour ammonia onto the valve or connection.* A chlorine or Sulfur Dioxide leak will create "smoke-like" fumes similar to cigarette smoke. Correct the leak before proceeding.
12. Open the cylinder valve 1/4 to 1/2 **turn only**, and leave the wrench on the cylinder valve when it is open.
13. The rate valve is not a shut-off valve. To shut-off chlorine, use the chlorine cylinder valve.
14. Always use safety chains or clamps to secure the chlorine cylinders so they may not be accidentally tipped over. Protective hoods and valve caps must be in place whenever cylinders are not in use.

NOTE: These instructions are also applicable to SUPERIOR Gas Sulfonators. Just substitute "sulfonator" wherever the word "chlorinator" appears and substitute "sulfur dioxide" wherever "chlorine" appears. Parts for the two types of units, except for the front and back bodies, the diaphragm front and back plates, and the remote meter panel bodies are interchangeable.

[‡]To prevent reliquification or condensing of Sulfur Dioxide (SO₂) gas in locations where the temperature may fall below 50°F (10°C), sulfonator installations should be inside a heated enclosure. DO NOT apply heat directly to chlorine or sulfur dioxide cylinders as this will cause a rapid increase in the gas pressure which could rupture the cylinder.

Contents

1.0 INSTALLATION

- 1.1 Handling of Chlorine Cylinders
- 1.2 Mounting Vacuum Regulator
- 1.3 Installation of Remote Meter Panel
- 1.4 Installation of Ejector
- 1.5 Piping of Ejector
- 1.6 Connecting Vacuum Regulator to Remote Meter and to Vent.
- 1.7 Automatic Switchover systems
- 1.8 Multiple Feed Point Systems
- 1.9 Additional Installation Suggestions

2.0 START-UP

- 2.1 Check Ejector
- 2.2 Check Chlorinator

3.0 SHUT DOWN

4.0 TROUBLESHOOTING

- 4.1 Chlorine Leak
- 4.2 Loss of Chlorine Feed
- 4.3 Sticky Ball in Remote Meter Tube/Rate Valve Panel
- 4.4 Water in Chlorinator - "Flooding"
- 4.5 Vacuum Leaks
- 4.6 Failure to Repeat Set Feed Rate
- 4.7 Icing of Metering Tube - Liquid Chlorine

5.0 SERVICE / DISASSEMBLY

- 5.1 Ejector Check Valve - Cleaning
- 5.2 Ejector Check Valve - Replacement
- 5.3 Cleaning / Inspection of Ejector Nozzle
- 5.4 Cleaning Chlorine Rate Adjustment Valve and Metering Tube
- 5.5 Cleaning Inlet Safety Shut Off Valve and Seat
- 5.6 Disassembly of Vacuum Regulator Body

1.0 INSTALLATION

(See Drawing No. 1)

IMPORTANT: Before proceeding, read "Precautions"

1.1 Handling of Chlorine Cylinders

Chlorine gas is potentially dangerous. The following rules must always be adhered to:

- 1.1.1 Never move a cylinder unless the valve protection cap is screwed on tightly.
- 1.1.2 Locate the cylinders where they will not be bumped or damaged.
- 1.1.3 A safety chain should be placed around the cylinders and secured to a wall or support.
- 1.1.4 When the vacuum regulator is mounted directly on the chlorine cylinder valve, the cylinder and chlorinator need not be in a heated room. For outdoor installation, when temperatures exceed 100° F., the cylinder should be shaded from direct sunlight.
- 1.1.5 Do not open the cylinder valve more than ¼ to ½ turn.

Note: The term "Chlorinator", as used in this publication, refers to the Vacuum Regulator, the Remote Meter Tube/Rate Valve Panel, and the Ejector Assembly, as a complete system.

1.2 Mounting Vacuum Regulator

(See Photo No. 1.1)

Follow these steps to mount vacuum regulator on the chlorine cylinder valve.

- 1.2.1 Unscrew the valve protection cap from the chlorine cylinder.
- 1.2.2 Check to make sure the cylinder valve is closed. Carefully unscrew the cap nut which covers the chlorine cylinder valve outlet.
- 1.2.3 Remove any dirt that may be in the valve outlet or on the outlet gasket surface.
- 1.2.4 Remove all shipping tape & inlet protective cap from the vacuum regulator. (DO NOT remove the porous, white filter which is inserted in the vacuum regulator inlet).
- 1.2.5 Unscrew the yoke screw until the sliding valve plate can be pushed all the way back.
- 1.2.6 Place 1/16" thick lead gasket over the chlorine inlet of

the vacuum regulator. *Never* use other types of gaskets or gasket materials. **Never re-use the lead gasket.** Replace the lead gasket each time the chlorine cylinder is changed.

- 1.2.7 Mount vacuum regulator on cylinder valve by placing the yoke over the valve, engage the vacuum regulator inlet properly with the valve outlet, and tighten the yoke screw, compressing the lead gasket. Excessive tightening will squeeze the lead gasket out of the joint and should be avoided. Do not open the chlorine cylinder valve until all components are installed. See section 2.0 "Start-Up".

1.3 Installation of Remote Meter Module

- 1.3.1 Install remote meter panel right side up in a location that is convenient for the operator and/or affords greatest security. Connect vacuum tubing from the vacuum regulator to the remote meter panel and from the remote meter panel to the ejector as shown in Drawing No. 1.

1.4 Installation of Ejector

(See Photo Nos. 1.2, 1.3, 1.4)

- 1.4.1 The check valves in the ejector are designed in such a manner that the ejector may be installed in any position.
- 1.4.2 The point of injection should be carefully chosen so that the water pressure at this point (back pressure) is as low as possible. Vacuum is created in the ejector by the nozzle which is actually a precision designed venturi. Water pressure to the nozzle must be high enough to overcome the back pressure and create a strong jet in the nozzle.
- 1.4.3 The standard ejector is designed to withstand static back pressures in excess of 250 psig (17.5 kg/cm²). However, due to possibilities of water line "torque" in high pressure on-off systems, as well as special booster pump considerations, it is recommended that a factory representative, or Chemical Injection Technologies, Inc. be consulted regarding installation details in systems over 100 psig (7 kg/cm²).
- 1.4.4 Generally, the amount of water (GPM) required to operate the ejector depends upon the chlorine flow rate (lbs./24 hrs. or gr./hr.). The higher the chlorine flow rate, the greater the water flow needed.



1.1

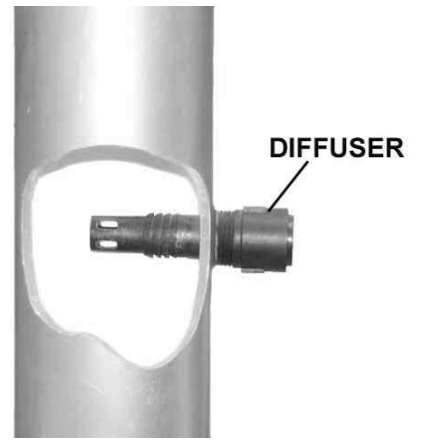

1.2

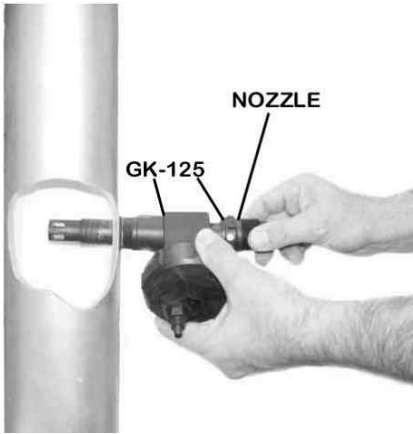

1.3



1.4



1.5

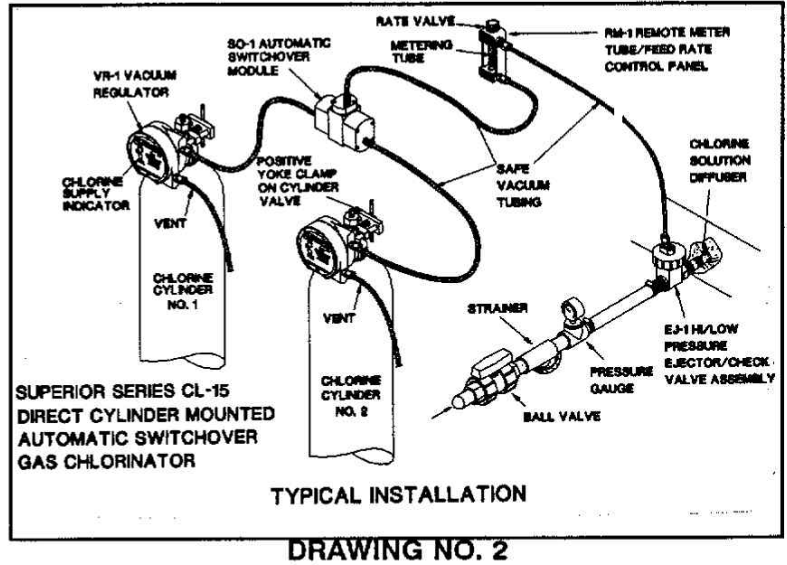
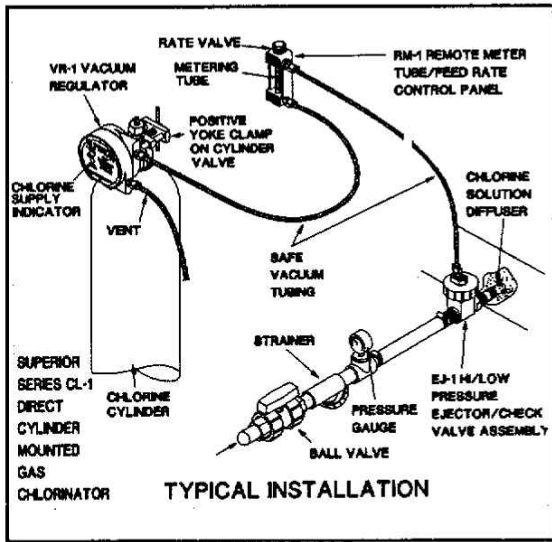

Typical Installation Drawings for the various Superior Gas Chlorinator/Sulfonator configurations. These drawings are provided strictly as a guide to help you understand the basic connections and relative placement of the modular assemblies. Each installation has its own unique requirements.

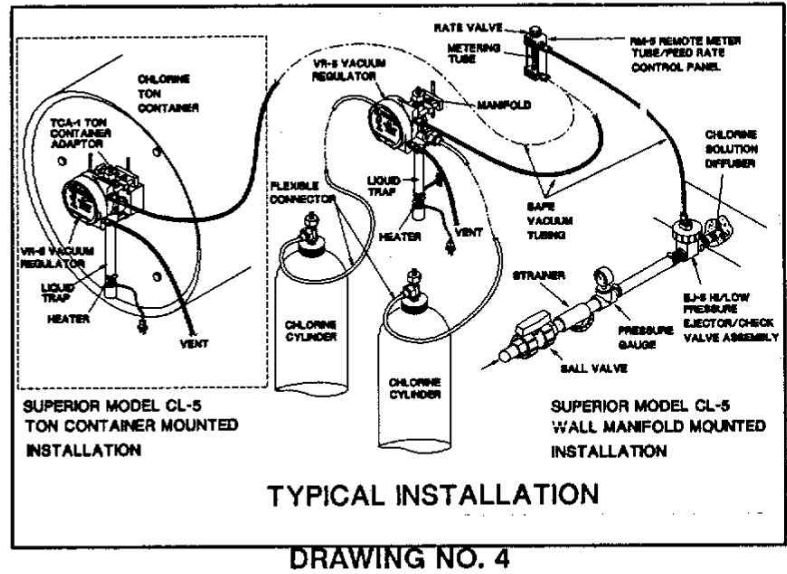
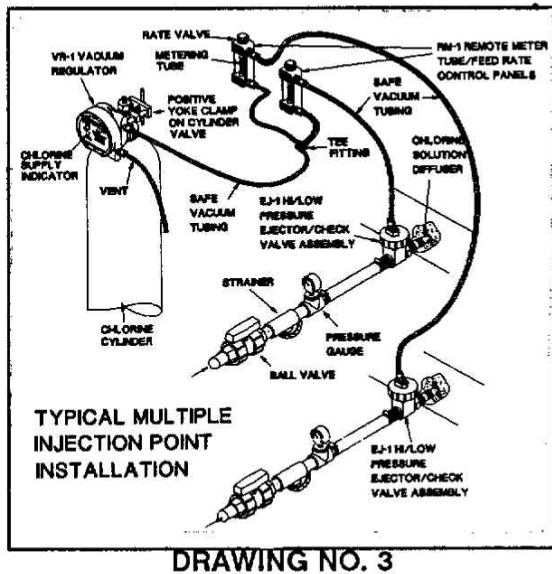

1.4.5 Ejector water supply pressure must be greater than the pressure into which solution is ejected. The amount of

pressure differential may vary with the particular application. Generally, the greater the pressure into

which the chlorine will be injected, the greater the required differential pressure. However, the minimum pressure differential and water flow for your installation should be determined prior to installation and start-up.

- 1.4.6 Follow these steps for installing close-coupled diffuser and ejector.
- Unscrew the diffuser from the assembly. **DO NOT** install the diffuser when the ejector is assembled or damage may occur.
 - Put Teflon tape on the 1" pipe threads and screw the diffuser into the pipe. These are high-strength plastic parts, but like all plastic pipe fittings, care should be exercised in tightening. Tighten carefully with properly adjusted wrench. Make sure that the holes in the spray type diffuser are in the main stream. The end of an open type diffuser should not allow strong chlorine solution to come into contact with metal pipe or fittings, as this will cause serious corrosion. (Photo No. 1.2).
 - Place a gasket (GK-125) into the recess on each side of the check valve body. Insert the nozzle through the check valve body (Photo No. 1.3). Hold the check valve body against the diffuser at ¼ turn **COUNTER CLOCKWISE** from its final position (up, down, side- ways).
 - Screw the nozzle into the diffuser, by **HAND ONLY**, until contact is made against both gaskets. Turn the check valve body and the nozzle, at the same time, ¼ turn clockwise to the final, tight position (Photo No. 1.4). Attach water supply hose and tighten clamps. (Photo No. 1.5).
- 1.4.7 Other types of diffuser and ejector installations may be desired for certain applications:
- The ejector (nozzle and check valve assembly) may be located near the vacuum regulator. A wall mounting bracket can be provided for the assembly, and the outlet can be supplied with various sizes of adaptors for solution hose or pipe.
 - If the ejector is to be remotely installed with solution piping or hose running to the point of application, be certain to cut off the tip of the diffuser before installing into the pipe or hose. Failure to do this will result in excessive back- pressure being created in the diffuser, causing chlorine feed rate to drop off or stop.
 - The entire diffuser-ejector assembly may be submersed in an open channel or tank.
 - Diffuser tubes with corporation cocks can be supplied for either close coupled or remote ejectors.
 - Special diffusers can be supplied for use with PVC Ball valves.

1.5 Piping of Ejector

- 1.5.1 For most installations, the ejector water supply line should be brought to within 3-5 feet of the nozzle with rigid copper or iron pipe, or schedule 80 PVC pipe.
- 1.5.2 A shut-off valve followed by a Y-type strainer and the ejector is desirable as a service tool, and is highly recommended.
- 1.5.3 A pressure gauge installed between the Y-type strainer and the ejector is desirable as a service tool, and is

recommended very strongly.

- 1.5.4 Connect hose between the hose adaptor and the ejector nozzle. Clamp the hose securely at both ends with single or double hose clamps. (Photo No. 1.5).
- 1.5.5 When rigid piping is used all the way up to the ejector inlet instead of hose, cut off the hose adaptor "barbs" on the nozzle where the 1" NPT threads start. Be certain to install pipe unions to allow maintenance.

1.6 Connecting Vacuum Regulator to Remote Meter and to vent

- 1.6.1 Appropriate size plastic tubing is normally used for the vacuum line between the vacuum regulator and remote meter; the remote meter and ejector; and for the emergency vent. Use enough length for each line to allow for movement of the vacuum regulator from one cylinder to another.
- 1.6.2 Remove connector nut from connector and slip onto tube. Push tube onto connector and tighten connector nut **HAND TIGHT.**
- 1.6.3 Upper connector on chlorinator vacuum regulator is for connecting the vacuum tubing to the bottom connector of the remote meter. The upper connector on the remote meter is for connecting the vacuum tubing to the ejector. The lower connector on the chlorinator vacuum regulator is for vent line exhausting to safe location outside building. An insect screen is provided for the outside of the vent line, and **MUST** be installed to prevent insects from entering the vacuum regulator and causing service problems.

1.7 Automatic Switchover Systems

(See Drawing No. 2.)

Mount vacuum regulators onto separate cylinder valves and install ejector as described above in sections 1.2 and 1.4.

- 1.7.1 Mount Automatic Switchover Module on wall as near as possible to the chlorine cylinders.
- 1.7.2 Mount the remote metering tube/rate control panel on wall, preferably between the automatic switchover module and the ejector.
- 1.7.3 Connect vacuum tubing from the "vacuum" outlet of each vacuum regulator to the tubing connectors on each side of the automatic switchover module.
- 1.7.4 Connect vacuum tubing from the tubing connector on the top of the switchover module to the tubing connector at the bottom of the remote meter panel, and connect tubing from the top connector of the remote meter panel to the ejector. [Special order "Right/Left" side remote meter panels are available which allow vacuum connectors to be installed on either side of the remote meter panel. Plugs are inserted in the unused fitting holes.]

1.8 Multiple-Point Feed Systems

(See Drawing No. 3)

Mount vacuum regulator onto cylinder as described in section 1.2. Mount each individual ejector as described in section 1.4. Connect vacuum tubing from vacuum regulator to remote meter panels, using tubing connector "Tees", and from individual meter panels to respective ejectors as shown in Drawing. No. 3.

NOTE: Each ejector must be installed as if it were a completely separate chlorination system, with the proper water flow and differential pressure.

1.9 Additional Installation Suggestions

- 1.9.1 Many operators find it convenient to install a "hook" on the wall behind the chlorine cylinder, slightly above the vacuum regulator. When changing cylinders, the vacuum regulator can easily be hung on this "hook" while moving new cylinders into place.
- 1.9.2 A beam-type scale should be used to weigh chlorine cylinders while in use to determine the amount of chlorine remaining.

2.0 START-UP

2.1 Check Ejector

- 2.1.1 The ejector, with its water supply and solution lines, must be properly installed and operating before checking the chlorinator: **IMPORTANT**: do not connect ejector to the chlorine vacuum tubing before applying water pressure to the ejector assembly. Dirt or debris can become lodged in the check valve during installation. Cycle the ejector on and off several times to insure tight closing. Failure to follow this procedure can cause water to enter the chlorinator, requiring disassembly.
- 2.1.2 Unless the ejector is creating a vacuum, the chlorinator will not work. Follow these steps:
 - a. Make sure the plastic vacuum tube is disconnected from the ejector.
 - b. With the booster pump running, or pressurized water supply connected, open the ejector water supply valve. The ejector should be in operation and creating a vacuum.
 - c. Put your finger on the vacuum connector opening of ejector and feel the vacuum. This is a strong vacuum and there should be no doubt that a vacuum exists. If there is no vacuum, refer to Section 1.4 and be certain the supply pressure is sufficient and that the nozzle or piping is not plugged. Correct the condition and obtain proper vacuum before proceeding.
 - d. Be sure that no water is coming out of the vacuum tube fitting when the ejector is shut off. If water is observed leaking past the check valve, see Service Section 5.1 and correct before proceeding.
 - e. Re-connect the vacuum tube to check chlorinator. Leave the ejector running.

2.2 Check Chlorinator

(Have strong household ammonia and a piece of cloth available to check for chlorine leaks. Avoid breathing the fumes).

- 2.2.1 With the ejector operating, and the chlorine cylinder still closed, the ball in the metering tube will remain at the bottom. If the ball does not remain at the bottom, or bounces up and down, there is either a leak at the lead gasket where the vacuum regulator connects on the cylinder or a loose connection in the system. Check and correct.
- 2.2.2 The supply indicator on the face of the vacuum regulator will be visible as RED. Double check by attempting to RESET the indicator. It should NOT be able to be reset.
- 2.2.3 Close the ejector water supply valve or turn off the booster pump to stop operation of the ejector.
- 2.2.4 Disconnect the plastic vacuum tube at the vacuum regulator and pull off the tube to allow air to enter system.

IMPORTANT: Before proceeding, read "Precautions".

2.2.5 Re-connect plastic vacuum tube. Open chlorine cylinder valve 1/4 turn and *close immediately*.

2.2.6 Wet small piece of cloth in household ammonia (avoid breathing fumes) and hold below the lead gasket inlet connection and below the cylinder valve bonnet. If chlorine is leaking, a smoke will appear similar to cigarette smoke. Tighten bonnet or replace gasket and eliminate leaks. (**NOTE**: Do not pour ammonia solution on the vacuum regulator or cylinder valve).

2.2.7 Open chlorine cylinder valve 1/4 turn, leave open, and recheck for chlorine leaks.

2.2.8 Turn on water supply valve to ejector and adjust rate valve to desired chlorine flow rate. Flow rate in lbs./24 hrs., or gr./hr. is read on the meter scale at the center of the ball for all flow rates except 200 to 500 PPD which are read at the top of the ball. Don't forget to reset the "Loss of Chlorine" indicator.

NOTE: NEVER use the rate valve to shut off the chlorine supply. This valve is for adjusting flow rate while the system is in operation. To shut off chlorine flow close the cylinder valve.

3.0 SHUT-DOWN

IMPORTANT: Before proceeding, read "Precautions".

- 3.1 Shut off water supply valve and/or booster pump.
- 3.2 Shut off the chlorine cylinder valve - not the rate valve.
- 3.3 When changing cylinders, follow the procedure on the cylinder changing chart supplied with your SUPERIOR Gas Chlorinator. Make certain that the cylinder valve is closed before removing the vacuum regulator.

Care and Maintenance of Your Superior Gas Chlorinator.

GENERAL

This section covers all phases of service on SUPERIOR Direct Cylinder Mounted Gas Chlorinators. Normally it is not necessary to completely disassemble the chlorinator unless the unit is to be cleaned throughout, or the unit has been severely flooded. **DO NOT DISASSEMBLE THE UNIT MERELY FOR THE SAKE OF DISASSEMBLY.** All units have been factory tested and are in perfect condition when they are shipped.

This text describes some of the things that can cause a chlorinator to stop working. Read it carefully and find out what the problem is before corrective measures are taken.

4.0 TROUBLESHOOTING

SUPERIOR Gas Chlorinators will require minimum service if operated with reasonable care. Problems which could arise are listed below.

4.1 Chlorine Leak

IMPORTANT: Before proceeding, read the "Precautions".

There are four possible points of chlorine pressure leaks. These are not unusual, but if a chlorine leak is detected it should be immediately located and stopped. Even small leaks can create a safety hazard and cause serious corrosion to equipment in the area. Ammonia should be used to detect leaks (as described in 2.2.6 under START-UP).

4.1.1 Chlorine cylinder valve packing.

The chlorine cylinder valve is a high quality valve designed specifically for chlorine service. Chlorine suppliers should service this valve at each filling and leakage at this point is unusual. Should a leak develop, tighten the cylinder valve packing nut without exerting excessive force. If this does not eliminate the leak, close the valve and call the chlorine supplier.

4.1.2 The lead gasket seal between the vacuum regulator and the chlorine cylinder valve.

A leak at this point is caused by:

- Reusing a lead gasket
- Dirt on the gasket surfaces
- Under or over tightened connection
- Installation without a gasket
- Using a "fiber" type gasket (only lead gaskets should be used).

Use a new lead gasket. Make certain the gasket and gasket surfaces are clean and smooth. Tighten clamp, but not excessively. (Photo No. 4.1)

4.1.3 Chlorinator shut-off valve - "Venting"

Chlorine leaking out of the vent is an indication of a leak at the safety shut-off valve. The usual cause is dirt on the valve seat. Test to make certain the problem is a leak at this point.

- a. Shut off water supply to ejector-diffuser.
- b. Submerge the end of the vent tubing in a glass of water. Continuous bubbling is an indication of a chlorine leak.
- c. Before removing the unit from the cylinder, close the cylinder valve, turn on the water supply, and allow the chlorinator to operate until the metering ball drops to the bottom.
- d. Refer to section 5.5 under "Service" (cleaning safety shut-off Valve and Seat).

4.1.4 Vacuum Regulator inlet capsule seat (adaptor face seal O-ring OR-103)

Chlorine leaking out between the back body and the yoke assembly, or from the space between the front and back bodies usually indicates a leak at the o'ring seal between the inlet valve capsule and the inlet adaptor. The usual causes are listed below. See section 5.5 under "Service".

- a. Improper tightening of the inlet valve capsule after disassembly.
- b. Dirt or impurities on the o'ring or sealing surfaces.
- c. Failure to re-install the OR-103 o'ring after disassembly.
- d. Damaged or worn OR-103 o'ring.

4.2 Loss of Chlorine Feed

(There are four possible reasons for loss of chlorine feed.)

4.2.1 No vacuum.

This can readily be checked by removing the chlorine gas line at the ejector-diffuser and holding your thumb over the fitting. Suitable vacuum will exert a strong pull. If there is no vacuum, the ejector nozzle may be plugged. Refer to section 5.3 under "Service" (Cleaning the Ejector nozzle).

4.2.2 Insufficient water pressure to operate ejector-diffuser.

This can be readily checked in the same manner as above by holding the thumb over the ejector vacuum fitting.

4.2.3 No chlorine supply.

This should be obvious. When the chlorine cylinder becomes empty, the metering ball will not indicate chlorine feed and the supply indicator on the vacuum regulator will show RED.

4.2.4 Plugged vacuum regulator inlet filter.

Dirt from the cylinder may completely plug the high-efficiency, porous filter. The filter may be removed for inspection and cleaning. See section 5.5.10 under "Service".

4.2.4 Broken or leaking vacuum line(s).

4.3 Sticky Ball in Remote Meter Tube/Rate Valve Panel

4.3.1 Deposits

- a. Chlorine gas may contain traces of organic compounds. These compounds can cause deposits on the ball or the glass tube. The deposit is often sticky, causing the ball to adhere to the surface of the glass. This can cause erratic operation. When this occurs it is necessary to clean the meter tube assembly. The cleaning procedure is outlined in section 5.4 under "Service" (Cleaning Chlorine Meter).
- b. Excessive amounts of lubricants applied to o'rings during service re-assembly can cause deposits to form on the metering tube ball and tube walls.
- c. The frequency of cleaning depends on a number of factors. Small chlorinators (below 10 PPD or 200 gr./hr.) will require cleaning more often than higher capacity units. The quality of the chlorine and the operating temperature of the installation affect the frequency of cleaning. Our experience indicates that a 10 PPD unit may have to be cleaned as often as every 4 or 5 months or may not require cleaning for several years.

4.3.2 Moisture in the system

- a. In the normal course of operation, moisture should not be present. However, it is possible in changing cylinders that very moist air could be drawn into the inlet. This can cause the metering tube ball to become "sticky" particularly on the bottom $\frac{1}{8}$ to $\frac{1}{4}$ of the tube.
- b. If the chlorinator has been previously "flooded" (see section 4.4) it is possible that all moisture has not been removed from the gas passageways in the vacuum regulator and/or remote meter/rate valve.
- c. A severe vacuum leak can allow moist air to enter the system. (see section 4.5).

4.4 Water in Chlorinator - "Flooding"

- 4.4.1 During chlorinator operation, vacuum draws chlorine gas through the system and water cannot enter the chlorinator. When the system is shut down, water under pressure is prevented from backing up into the chlorinator by means of a back flow check valve. Any water observed in the chlorinator indicates a failure of the back flow check valve to seal properly. If the leak is severe or the check valve is damaged, water may be observed coming out of the "vent" tubing:
 - a. Shut off the water supply to the ejector and the water in the main, so there is no pressure in the ejector piping.
 - b. Remove the vacuum tube from the ejector and follow instructions for "Cleaning Ejector Check Valve", Section 5.1 and for "Replacing Ejector Check Valve", Section 5.2, if damage is observed.
 - c. Close the chlorine cylinder valve and remove the vacuum regulator from the cylinder. Remove the metering tube from the remote meter module and follow instructions in Section 5.4 "Cleaning Rate Adjustment Valve and Metering Tube".
 - d. Follow instructions for "Disassembly of Vacuum Regulator Body" in Section 5.6 and be certain all moisture is removed before reassembling. Also, be certain no moisture remains in the vacuum tubing between the vacuum regulator and remote meter panel.
 - e. Follow "Start-Up" procedure in Section 2.

4.5 Vacuum Leaks

- 4.5.1 For best operation all parts of the chlorinator system should be air-tight, since vacuum leaks will permit air to enter the system. All units are vacuum tested at the factory prior to shipment, therefore, a vacuum leak on a new unit is unlikely. Furthermore, it is very unusual for leaks to develop during operation unless the unit has been disassembled.
- 4.5.2 A simple test determines whether or not a chlorinator system is free of vacuum leaks. Proceed as follows:
 - a. Operate the chlorinator normally at any arbitrary chlorine setting.
 - b. Shut off the chlorine cylinder valve. (It is assumed that the cylinder valve will shut off tightly. A defective valve will give erroneous results).
 - c. The ball in the chlorine meter should drop to zero. (For very low capacity units this may take as long as 5 minutes). If the ball does not drop to the bottom this indicates a vacuum air leak at some point in the system, usually between the chlorine inlet and the metering tube.

- d. When the ball drops to zero, shut off the ejector supply water. Note that the chlorine supply indicator can not be reset to GREEN. With a perfectly tight system this condition will remain. Usually a 5 or 10 minute check is all that is required. If a leak exists in the system, the diaphragm assembly will move allowing the chlorine supply indicator to be reset. If you are unsure about the position of the indicator, remove the "vent" tubing from the lower vacuum tube connector. Using some "soapy" water (water and dishwashing detergent are best) place a soap "bubble" over the connector hole. If the bubble gets larger it indicates that a vacuum leak exists.

4.5.3 The most common cause of vacuum leaks is improper assembly of units that have been taken apart for servicing.

4.5.4 The most common points of leakage are listed as follows:

- a. Chlorine metering tube gaskets

If the chlorine meter is not installed straight or the rate valve seat (RV-130) is not tightened properly a leak could develop.

NOTE: Excessive tightening can also cause a leak. Metering tube gaskets can be re-used. However, except for "Lip" type gaskets, they should be turned over to re-use.

- b. Rate valve o'rings

Rate valve o'rings (OR-102) may become worn. Fouling of the surfaces might cause abrasion of the o'ring surface.

- c. Sealing surface at main diaphragm

An imperfection or speck of dirt on this surface during reassembly may cause a vacuum leak, but SUPERIOR's use of a compression sealing o'ring (OR-108) makes this unlikely.

- d. Vacuum tubing and connectors

Check vacuum tubing for cracks, particularly under tubing connector nuts. Check vacuum tubing connectors.

- e. Other possible points of leakage which are not as common:

- (1) O'ring at inlet capsule (OR-106)
- (2) Vent seal on diaphragm (OR-110)

4.6 Failure to Repeat Set Feed Rate

- 4.6.1 On start-up (where the chlorinator is actuated automatically with water flow) a chlorinator with a dirty meter or rate adjustment valve may not repeat. This is particularly true of low capacity units below 10 PPD chlorine feed rate. Correction of this situation can be accomplished by:
 - a. Cleaning the rate adjustment valve as outlined in Section 5.4.
 - b. Cleaning the chlorine meter as outlined in Section 5.4. The frequency of cleaning depends on the quality of chlorine.
- 4.6.2 Failure to repeat may also occur if the chlorinator has been flooded and moisture remains in the metering and rate adjustment areas.

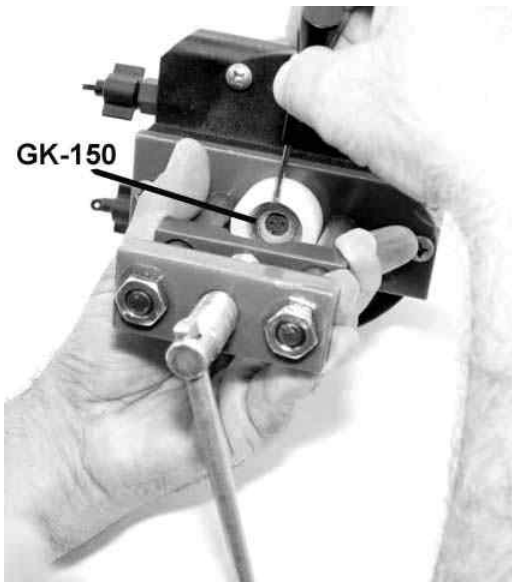

4.1

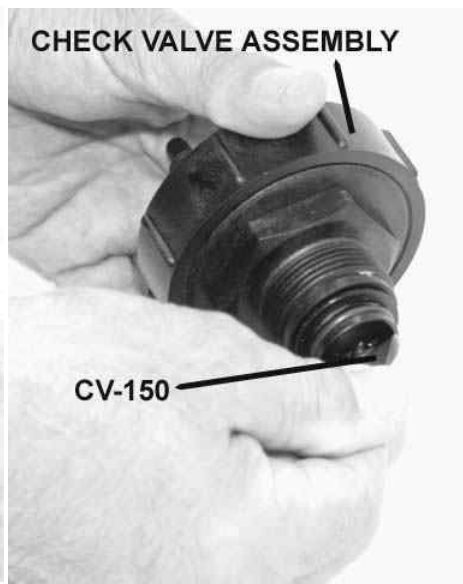

5.1



5.2

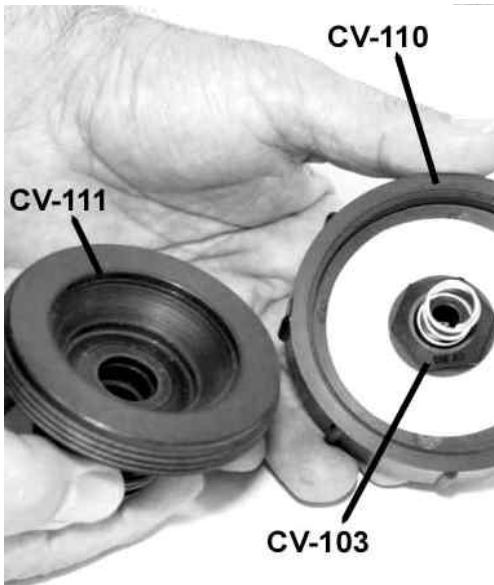

5.3

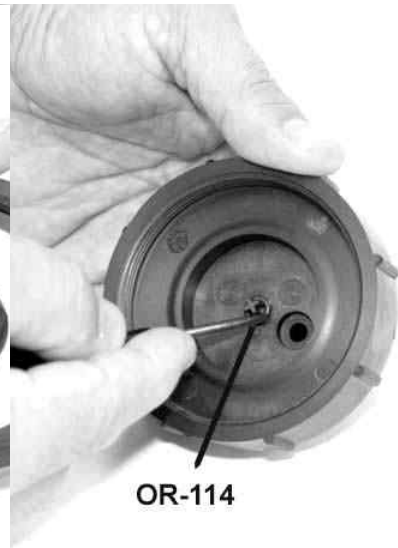

5.4



5.5



5.6

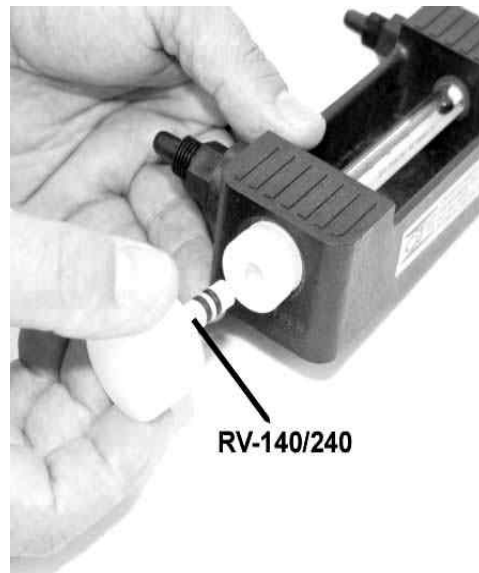

5.7

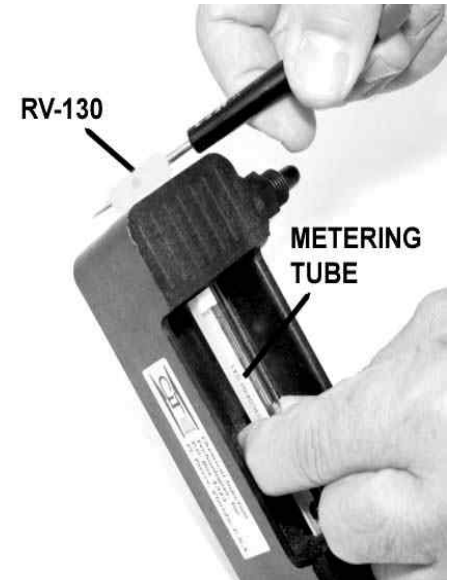

5.8

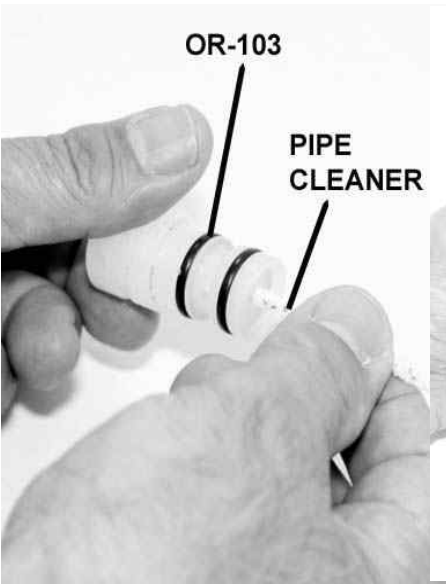

5.9



5.10

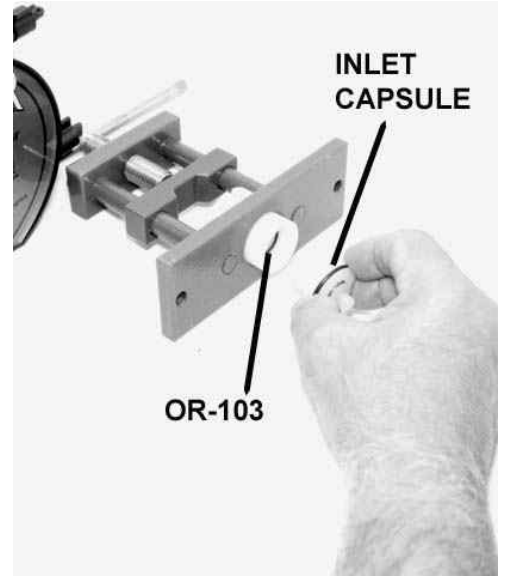

5.11

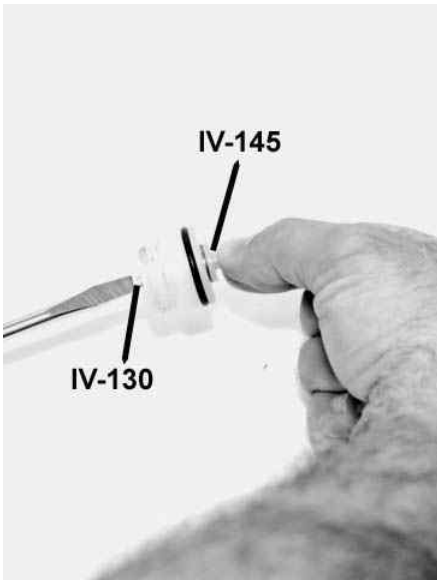

5.12

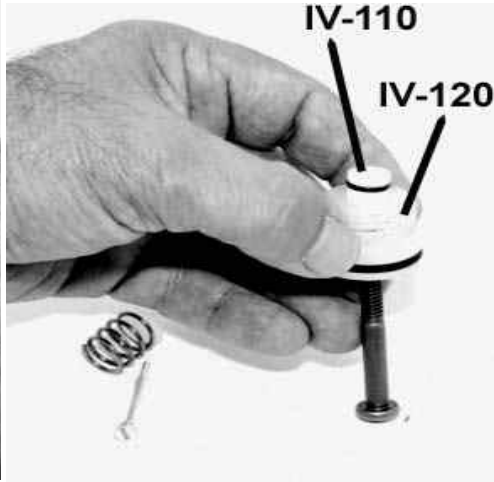

5.13

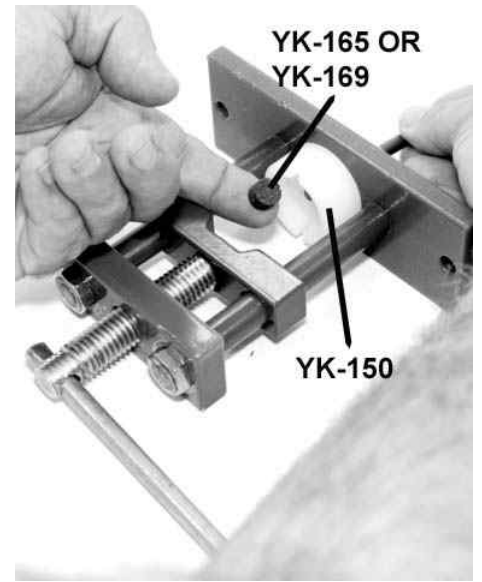

5.14

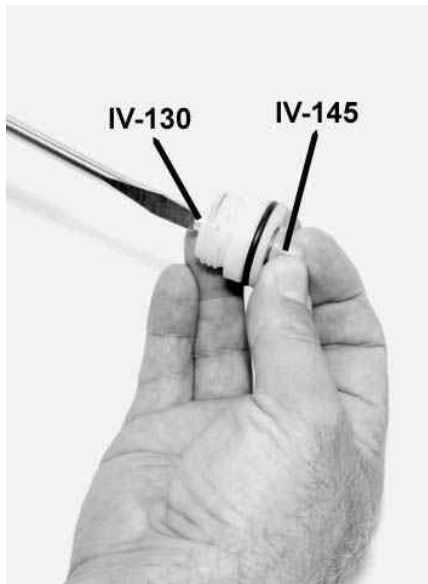

5.15

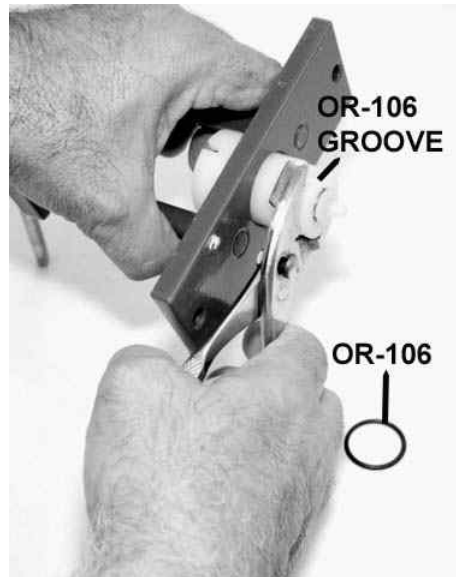

5.16

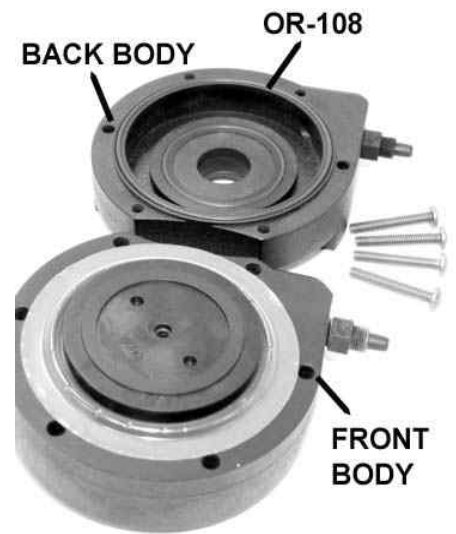

5.17

4.7 Icing of Metering Tube - Liquid Chlorine

- 4.7.1 If ice is observed forming on the remote meter tube it is a definite indication that liquid chlorine has entered the chlorinator from the cylinder. While this is extremely rare, our experience has shown that chlorine suppliers have been known to overfill chlorine cylinders (rarely) causing liquid to enter the chlorinator. Also, if the cylinder should be tipped over while the chlorinator is operating, liquid may be drawn into the system.

Ton Containers; If the vacuum regulator is mounted directly onto the gas outlet valve of a ton container (using a ton container adaptor), it is possible that the "dip" tube inside the container has been broken off or a hole has developed, allowing liquid chlorine to be drawn into the vacuum regulator instead of gas. Also, check to be certain that the heater on the adaptor is keeping the drip leg warm. It is possible for liquid chlorine that is trapped in the inside "dip" tube of the container to be drawn through the adaptor, when a ton container is first used. Make sure that the regulator is connected to the TOP valve, and that the two valves are aligned vertically.

Wall Manifolds; Gas vapor can condense and form droplets of liquid chlorine, particularly when there is a sudden temperature drop in the flexible connectors. Make sure that the "drip Leg" heater is connected and that the drip leg is warm to the touch. Do not allow cylinders or ton containers to be in an area where they can become warmer than the flexible connectors or manifold piping (example: cylinder placed where sunlight through a window can shine on it but not on the manifold piping).

- 4.7.2 If the chlorinator has been subjected to liquid chlorine, do the following:

IMPORTANT: Before proceeding, read "Precautions"

- a. Shut off the cylinder valve.
- b. Leave the ejector running and pulling vacuum on the chlorinator for several minutes.
- c. Remove the vacuum regulator from the cylinder.
- d. Keeping your face away from the regulator, quickly remove the vacuum tubing from the "vacuum" outlet on the vacuum regulator, to "break" the vacuum lock in the regulator.
- e. Re-connect the vacuum tube. Observe that the metering tube ball indicates gas flow (air). The chlorinator will now draw air into the chlorinator inlet and through the chlorinator, vaporizing any remaining liquid. If the metering tube ball drops to the bottom, it means that the vacuum regulator has "locked up" due to excessive air flow rate. If this happens close the rate valve, remove the vacuum tube from the regulator again and quickly reconnect it. Open the rate valve until air flows at a steady rate. Allow the chlorinator to draw air for several minutes.
- f. Shut off ejector.
- g. Either **OUTDOORS** or in a **WELL-VENTILATED ROOM**, follow instructions for "Disassembly of Vacuum Regulator Body" (Section 5.6). Clean with wood alcohol or Apple Cider vinegar and replace any parts that show signs of chlorine attack.
- h. Reassemble and follow **START-UP** procedure in Section 2.

5.0 SERVICE/DISASSEMBLY

IMPORTANT: Before proceeding, read the "Precautions for Personal and Chlorinator Protection" on Page 1.

Before attempting to disassemble any of the SUPERIOR Gas Chlorinator components, refer to Section 4.0 TROUBLE HINTS to isolate the cause of the problem. Below are listed the various sections under SERVICE.

Section 5.1 Ejector check valve - cleaning.

Section 5.2 Ejector check valve - replacement.

Section 5.3 Cleaning/Inspection of ejector nozzle.

Section 5.4 Removing and cleaning chlorine rate adjustment valve and metering tube.

Section 5.5 Cleaning inlet safety shut-off valve and seat.

Section 5.6 Disassembly of vacuum regulator body.

5.1 Ejector Check Valve - Cleaning

5.1.1 Two check valves are installed in the standard ejector assembly to prevent water from backing into the chlorine gas system when the ejector is shut off. (Note: a special "Low Pressure" ejector is sometimes provided for installations where chlorine solution is being applied directly into an open tank - This ejector contains only the Low Pressure check valve. Follow directions that apply only to low pressure check valves). The check valves are designed so that it is extremely difficult for dirt to get under the valves, but dirt can enter from the chlorine side of the valve, or work its way under the valve from the water supply if large amounts of sand or other impurities are present.

To remove and clean the valves:

- Shut off the water supply to the ejector and the water in the main.
- Remove vacuum tube.
- Unscrew the check valve assembly counter-clockwise from the ejector body (EJ-110). Wrench lugs are located on the underside of the check valve assembly if you cannot unscrew it by hand.

HIGH PRESSURE CHECK VALVE:

- Carefully* lift the edge of the check valve (CV-150) (Photo No. 5.1) and inspect. Clean both the valve and the seating surfaces with wood alcohol or apple cider vinegar. Do not use any solvents.
- When re-installing the check valve assembly, put a *small* amount of "Fluorolube" or Dow Corning DC33 silicone grease on the seat o'ring (OR-105) and seat gasket (GK-120) for lubrication.
- Screw check valve assembly (clockwise) into ejector body. **USE NO TOOLS, HAND TIGHTEN ONLY.**
- Pressurize the ejector and cycle several times before reconnecting the vacuum tubing to insure that the check valve is sealing properly.

LOW PRESSURE CHECK VALVE:

- The low pressure check valve is housed inside the check valve assembly. Any cleaning or service requires disassembling the entire check valve assembly. Unless a leak is observed, or you wish to replace the low pressure check valve seat as preventive maintenance, it is recommended that you do not disassemble the unit. If disassembly is required, follow instructions under "Replacement", below, and always replace the low pressure check valve seat o'ring (OR-114).

5.2 Ejector Check Valve - Replacement

5.2.1 HIGH PRESSURE CHECK VALVE: After inspecting the check valve as described in 5.1 above, if wear or damage is noted, the check valve (CV-150) should be replaced.

- Grasp the outer edges of the check valve (CV-150) and apply a steady pulling force until the "umbrella" tip pops free. Be certain it is completely removed.
- Examine the check valve seat sealing surface for deposits and clean with wood alcohol or apple cider vinegar.
- Check the seat sealing surface with a straight-edge to be certain that it is completely flat. If the center is slightly raised, you will see light under the straight-edge or it will "rock" over the center. If the seat sealing surface is not flat, use a very fine sand- paper or emery cloth on a flat surface (plate glass), and gently move the check valve seat in a *figure 8 pattern only*. Do not rub back and forth or the seat will become distorted.
- Coat the tip of new check valve with a very light film of DC33 silicone grease. Put the tip of the check valve in the check valve seat hole and using the handle of a screwdriver or other rounded object, push against the center of the check valve until the tip snaps into seat. (Photo No. 5.2).

DO NOT TWIST CHECK VALVE OR DAMAGE MAY OCCUR.

5.2.2 LOW PRESSURE CHECK VALVE: if water has been observed coming out of the vacuum tube fitting on the check valve assembly, it will be necessary to disassemble the check valve housing, and replace the check valve seat o'ring, and possibly the check valve diaphragm if it is damaged.

- Hold the check valve seat/outlet body (CV-110) with a wrench or place the wrench lugs in a vise. Using a 1 inch open-end wrench, place the wrench on the "outside" of the raised wrench lug on top of the check valve inlet body (CV-111). This is the side into which the vacuum fitting is screwed. Turn the inlet body counter-clockwise to unscrew it.
- When disassembling, note the position of the diaphragm and spring. Usually, the spring will remain attached to the diaphragm bolt (CV-103). (Photo No. 5.3)
- Inspect the check valve seat o'ring for dirt or deposits. The o'ring may be cleaned and re-used, but it is recommended that the o'ring be replaced whenever the unit is disassembled. (Photo No. 5.4)
- Inspect the check valve sealing surface on the diaphragm bolt (CV-103) and clean with wood alcohol or apple cider vinegar.
- If the diaphragm (CV-104) has been damaged or has been severely distorted, it must be replaced. When re-assembling the diaphragm assembly, be certain that no dirt or debris is on the sealing surfaces of the diaphragm, the diaphragm bolt (CV-103) or nut (CV-105). Be careful when tightening the diaphragm bolt and nut to avoid tearing the diaphragm. (Photo No. 5.5)

- f. Re-assemble by placing the spring and diaphragm assembly into the recessed hole in the outlet body (CV-110). Make sure that the diaphragm assembly is centered and carefully place the inlet body (CV-111) over the threads of the outlet body. Hand tighten until resistance is felt. Using a wrench or vise to hold the outlet body, and a 1" open-end wrench on the inlet body (see 5.2.2.a), tighten down the inlet body until snug. DO NOT OVER-TIGHTEN.

5.2.3 Examine seat o'ring (OR-105) and seat gasket (GK-120) for wear or damage and replace if necessary.

5.2.4 When reinstalling the check valve assembly, put a small amount of DC33 silicone grease on the seat o'ring (OR-105) and seat gasket (GK-120) for lubrication. It is recommended that Teflon pipe sealing tape be applied to the threads of the check valve assembly.

5.2.5 Screw check valve seat (clockwise) into ejector body. *USE NO TOOLS. HAND TIGHTEN ONLY.*

5.3 Cleaning/Inspection of Ejector Nozzle

5.3.1 To remove the ejector nozzle for cleaning, the water pressure in the main must first be shut off unless the ejector was initially installed with a valve on the inlet side and a ball valve or corporation stop in the outlet so that isolation of the ejector is possible.

5.3.2 Remove the ejector supply hose and chlorine vacuum tubing from the ejector assembly.

5.3.3 Rotate the complete ejector body counterclockwise, making certain that the solution outlet remains fixed (use wrench if necessary). This loosens the threaded portion of the nozzle from the solution diffuser and simplifies removal.

5.3.4 Unscrew the nozzle (EJ-130). The ejector body, the nozzle and the diffuser (EJ-150) are now separated. (Photo No. 5.6).

5.3.5 Nozzle plugging can be caused by:

- a. Piece of foreign material (pipe sealer, stone or dirt accumulation). This can be readily blown out or pushed out very carefully, with a wire in the reverse direction. Do not use sharp tools or alter the size of the orifice in any way.
- b. Excess plastic pipe solvent used during initial installation of inlet piping. If such solvent has chemically bonded to the nozzle orifice, the nozzle must be replaced.
- c. Build-up of deposit. This could be a chemical build-up of iron, manganese or other material which usually can be removed by immersing the nozzle in muriatic acid and rinsing. CAUTION: Read all warning labels on Muriatic Acid bottle and avoid skin contact. It is recommended that safety goggles or face shield be used when working with any strong acid. Some waters are such that this build-up can cause an ejector to become inoperative every two months. If build-up is excessive and requires constant cleaning, you may consider the possibility of adding "sequestering" chemicals (such as hexametaphosphate) into the ejector water supply line. Consult local regulatory agencies before adding any chemicals to a potable water system.

5.3.6 To re-install the nozzle:

- a. Insert the nozzle through the ejector body and fasten to the solution diffuser outlet (EJ-150) using new gaskets (GK-125) on each side of ejector body.
- b. Hold the ejector body (EJ-110) against the diffuser at ¼ turn COUNTER-CLOCKWISE from its final position; up, down, sideways, etc. (see installation Section, Photo No. 1.3).

c. Screw the nozzle into the diffuser, BY HAND ONLY, until contact is made against both gaskets.

d. Turn the ejector body and the nozzle, at the same time, ¼ turn clockwise to the final tight position. (See Installation Section, Photo No. 1.3).

e. Re-install the ejector supply hose and chlorine vacuum tubing.

5.3.7 Open all valves and check for proper vacuum. (See Section 2.1).

5.4 Cleaning Chlorine Rate Adjustment Valve and Metering Tube.

5.4.1 Unscrew the rate valve plug assembly (RV-140) from the top of Remote Meter Assembly, (Photo No. 5.7) and pull the plug assembly with steady pressure until it "pops" out of the rate valve seat. (Photo No. 5.8).

5.4.2 Insert a nail or thin screwdriver *through* two of the four holes in the top of the rate valve seat. While holding the chlorine flow metering tube with one hand, turn the seat counter-clockwise. The metering tube will loosen and may be removed, (Photo No. 5.6).

5.4.3 Continue unscrewing the rate valve seat until it is free of its threads. Grasp the rate valve seat and pull up until it pops out.

5.4.4 To clean the rate valve plug (RV-140):

- a. Clean the silver tip and shaft using a cloth dipped in lacquer thinner or acetone. CAUTION: Do not use any lacquer thinner or acetone on o'rings. This can cause the material to soften or become damaged.
- b. Use a mild solvent, such as alcohol to clean o'rings. Examine the o'rings (OR-102) and make sure they are free of bruises or scratches. Replace if necessary. Use a light film of DC33 silicone grease on the o'rings and threads.

5.4.5 To clean the rate valve seat (RV-130):

- a. Use a cotton swab (Q-Tip) with a small amount of wood alcohol and clean out the inside of the rate valve seat.
- b. If dirt or deposits have formed in the metering orifice of the rate valve seat, a pipe cleaner dipped in alcohol can be carefully inserted through the orifice and gently moved back and forth. (Photo No. 5.9).
- c. Clean the metering tube gasket surface with the cotton swab.
- d. Inspect and clean the rate valve seat o'rings (OR-103) with alcohol. Replace if damaged or worn.

5.4.6 To clean the metering tube assembly:

- a. Use tweezers or needle nosed pliers and pull out the float stops on each end of the glass tube. MAKE SURE THE METERING BALL IS NOT LOST.
- b. Clean the inside of the glass tube with a pipe cleaner using wood alcohol and rinse thoroughly with warm water. Clean the metering ball float.

- c. Dry out the glass meter with an air hose. (NOTE: Never use compressed air when the metering ball float is in the tube). If none is available, a hot water rinse will dry out by itself in a few minutes.
 - d. Re-install ball float and float stops.
- 5.4.7 Place Teflon pipe tape on threads of the rate valve seat (RV-130) and apply a thin film of DC33 silicone grease to the o-rings. Snap valve seat in place until the threads can engage. Turn the rate valve seat clockwise 1-1/2 turns.
- 5.4.8 Replace the chlorine metering tube:
- a. The metering tube gaskets can usually be re-used. If damaged, replace them. Place one gasket on the bottom of the rate valve seat and one gasket in the recess of the chlorinator body at the bottom of the metering tube area. (NOTE: some sizes of metering tubes use larger "Lip" type gaskets on the top than on the bottom).
 - b. Center the top of the metering tube under the rate valve seat and center the bottom over the hole in the lower gasket.
 - c. Using the rate valve removal tool (nail) or pliers tighten (clockwise) the rate valve seat while holding the metering tube in place with numbers of proper scale facing front. Be sure the tube is centered over the gasket holes.
 - d. When the metering tube no longer can be rotated easily, tighten the rate valve seat another ¼ to ½ turn. Do not over tighten so as to squash the gaskets since this can cause a vacuum leak.
- 5.4.9 Replace the Rate Valve Plug assembly (RV-140) by placing it into the top of the rate valve seat and gently pushing down until the O-ring pops into the seat and the threads can engage. Tighten down the rate valve a few turns.

5.5 Cleaning Inlet Safety Shut Off Valve and Seat

- 5.5.1 Remove the two screws holding the yoke body bar (YK-100) to the vacuum regulator body.
- 5.5.2 Pull the entire yoke assembly from the vacuum regulator body. A clockwise rotation helps if the o-ring seal is tight. It should slip out relatively easily. (Photo No. 5.10)
- 5.5.3 To disassemble the inlet capsule, turn the inlet adaptor plug (IV-120) counter-clockwise. If the plug is tight, use a narrow pliers but be careful not to damage the adaptor o-ring (OR-106). The end of the valve plug (IV-130) is now exposed (Photo No. 5.11).
- 5.5.4 Insert a screw driver into the slot in the end of the inlet valve plug (IV-130) and unscrew the inlet vent plug/spring guide (IV-145). This can often be unscrewed by hand. (Photo No. 5.12). If pliers are necessary make sure the rounded seat surface is not scratched. (NOTE: This assembly is in tension with the inlet spring (IV-160) so be careful not to lose the vent plug/spring guide).
- 5.5.5 Remove the inlet valve plug (IV-130) and inlet spring (IV-160).
- 5.5.6 Inspect the sealing surface of the inlet valve seat (IV-110). This surface must be completely free of dirt, nicks, or scratches. A magnifying glass gives a good indication of the quality of the seat. Use a cotton swab dipped in lacquer thinner, acetone or alcohol to carefully clean the seat. DO NOT attempt to clean the seat with a sharp tool. Replace the valve seat if it is not in perfect condition. (Normally it will not be necessary to remove the valve seat from the inlet adaptor plug (IV-120) unless it needs to be replaced). To remove, use one of the chlorinator body screws inserted through the inlet spring side of the adaptor plug. Place the head of the screw against a hard surface and push firmly on the adaptor until the valve seat pops free. (Photo No. 5.13).
- 5.5.7 Immerse the inlet valve plug (IV-130) and vent plug (IV-150) in lacquer thinner or acetone. Usually a deposit

of crystalline organic material or a hard varnish like material will form along the valve stem below the valve seating surface. Wipe the surfaces clean with a clean cloth and inspect the tapered valve seating surface, and the rounded vent plug sealing surfaces. These surfaces must be completely free of dirt, nicks and scratches.

- 5.5.8 Clean the inlet adaptor (YK-150) before proceeding with assembly. A small tube or bottle brush (or cotton swab) with lacquer thinner or acetone works well here. Remove and inspect the adapter face seal o-ring (OR-103) before applying any cleaning solvent to the adaptor. Replace the o-ring if scratched or damaged.
- 5.5.9 The adaptor face seal o-ring (OR-103) and all other parts may be cleaned with a clean cloth dipped in wood alcohol.
- 5.5.10 The inlet filter disk (YK-165) may be removed for inspection of dirt build-up and for cleaning by pushing a pencil eraser tip through the inlet adaptor (YK-150), (See Photo No. 5.14). Dirt and deposits can usually be removed by immersing the filter in muriatic acid. **CAUTION:** Read all warning labels on muriatic acid container. Use only in a well ventilated area. Avoid skin contact. Do not breath vapors. Safety goggles or face shield should be worn. Dry filter thoroughly with air hose or dryer. If local, state, or federal regulations prohibit storage or use of Muriatic acid at your site, try using some apple cider vinegar. If this does not get the filter clean, then replace the filter.

5.5.11 TO REASSEMBLE proceed as follows:

- a. Replace the filter in the adaptor inlet using finger pressure.
- b. Replace the inlet valve seat (IV-110) and valve seat o-ring (OR-104) if they were removed from the adaptor plug. A *very light film* of DC33 silicone grease should be put on the o-ring and the seat slowly "pumped" into the adaptor plug.
- c. Insert the inlet valve plug (IV-130) through the valve seat.
- d. Place the inlet adaptor plug with the inlet valve plug facing down on a smooth clean surface and proceed.
- e. Insert the inlet spring guide/vent plug onto the inlet spring and snap into place. Insert the inlet spring with guide/vent plug attached, into the inlet adaptor plug recess.
- f. Compress the spring guide/vent plug and screw it on to the inlet valve plug a few turns by hand.
- g. Place a screwdriver in the inlet valve plug slot, hold the spring guide/vent plug with the other hand and screw down the spring guide/vent plug until the spring guide bottoms on the shoulder of the inlet valve plug. DO NOT OVER-TIGHTEN (Photo No. 5.15). The spring should compress until approximately 1/32" (1mm) of clearance is observed between the top of the adaptor plug and the bottom of the spring guide/vent plug. (NOTE: A screwdriver tip that fits the inlet valve plug slot is a good measuring tool).

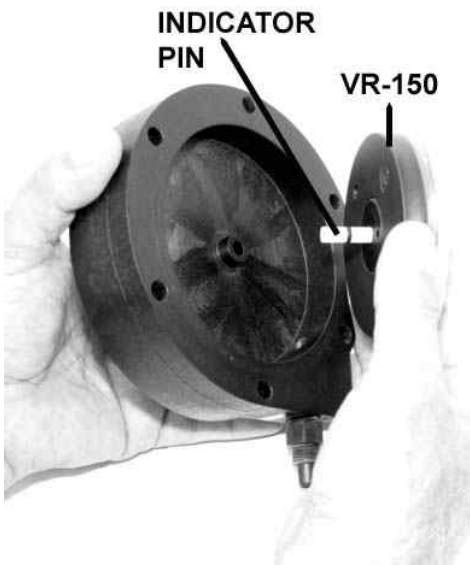

5.18

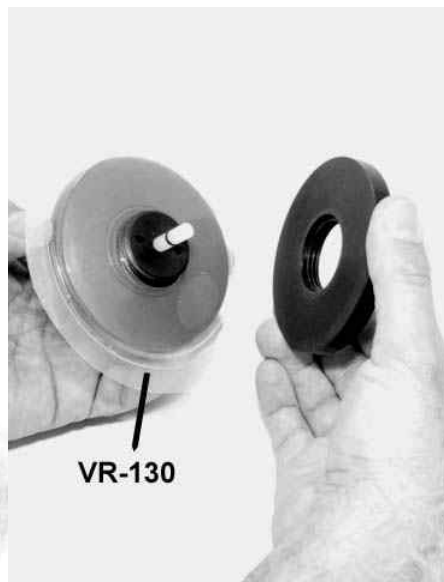

5.19



5.20

1/16" GAP (1.6 MM)



5.21

- h. Check alignment of valve stem assembly. It should appear straight when viewed from any direction.
- j. Screw the inlet adaptor plug assembly into the yoke assembly, clockwise. Use pliers and tighten until you are certain the plug is bottomed. The plastic used in this plug is very strong, just be careful that you do not damage the inside of the adaptor plug OD sealing o'ring groove. (Photo No. 5.16).
- i. Place the adaptor face seal O-ring (OR-103) into the groove in the inlet adaptor.

5.5.12 Put a light film of DC33 silicone grease on the adaptor plug OD sealing O-ring (OR-106). Also put a light film of lubricant on the back body inlet seal (OR-113).

5.5.13 Insert the entire yoke assembly into the chlorinator body using a slight **CLOCKWISE ROTATION**. **DO NOT** turn the yoke assembly counter-clockwise as a precaution against unscrewing the inlet safety capsule.

5.6 Disassembly of Vacuum Regulator Body

Normally it is not necessary to completely disassemble the unit unless a thorough cleaning is necessary or parts need replacing.

5.6.1 Remove the yoke assembly as described in Section 5.5.1 and 5.5.2.

5.6.2 If Necessary, remove the two small screws which hold the faceplate onto the front body. Carefully remove the faceplate.

5.6.3 Remove the four screws which hold the body assembly together and separate the body halves. (Photo No. 5.17).

5.6.4 Grasp the diaphragm back plate (VR-141)* and pull the entire diaphragm assembly out of the front body. (NOTE: VR-140 and VR-160 are assembled as VR-141). If the white indicator pin is sticking in the front body, carefully use a nail to push the pin through from the front of the vacuum regulator. (Photo No. 5.18).

5.6.5 Examine the diaphragm. It is normal for some wrinkles to be present. The diaphragms are made of special, very tough, chlorine resistant material and failure is extremely unlikely.

Should it be necessary to disassemble the diaphragm proceed as follows:

- a. Grasp both the front and back diaphragm plates and unscrew them. (Photo No. 5.19). If the plates cannot be unscrewed by hand you may use a vise to clamp one of the plates and use a strap wrench or marine deck plate spanner wrench to unscrew the other.
- b. The diaphragm can now be removed. *Note the position of the "convolution" on the diaphragm.* **The raised portion should always face the back of the chlorinator when installed.**

5.6.6 Clean the parts thoroughly using wood alcohol or Apple Cider vinegar.

5.6.7 Carefully inspect all o'rings for damage or wear and replace if necessary.

NOTE: Excessive use of lubricants can cause additional service problems.

5.6.8 Reassemble the unit using the reverse procedure and check the following:

- a. Be certain that the main diaphragm seal o'ring (OR-108) is properly seated.
- b. Be certain that the diaphragm assembly moves freely in the front body. Press it forward several times to be certain it returns to "neutral position". (Photo No. 5.20).
- c. Place the back body (VR-110) on a table with the diaphragm body seal o'ring (OR-108) in place and lower the front body (VR-120) onto it.
- e. Grasp the entire unit and turn it over so the back body is on top and re-assemble the four 1-1/2" (38mm) long screws. These screws should be run in until they just begin to tighten.

5.6.9 Replace the yoke assembly using procedure described in Section 5.5.13, turning it slightly **CLOCKWISE** as it is inserted.

5.6.10 Tighten all bolts in a criss-cross pattern until they are all snug. Do not over tighten. Sealing is accomplished by the large o'ring between the bodies (OR-108). **THERE SHOULD BE A GAP OF APPROXIMATELY 1/16" (1.6mm) BETWEEN THE TWO BODY HALVES. DO NOT ATTEMPT TO CLOSE THIS GAP BY TIGHTENING THE BODY SCREWS.** (Photo No. 5.21).

IMPORTANT NOTE: DO NOT USE ANY LUBRICANT (DC 33 GREASE) ON THE FOLLOWING O-RINGS

- OR107
- OR-108
- OR-109
- OR-110

Chemical Injection Technologies, Inc.
4796 S. US 1, Ft. Pierce, FL, 34982, USA
(772) 461-0666 Fax: (772) 460-1847
E-Mail: chlorine@gate.net
www.chlorinators.com
